

WHISPER[®] Cellular LiteRise Shades

Installation • Operation • Care

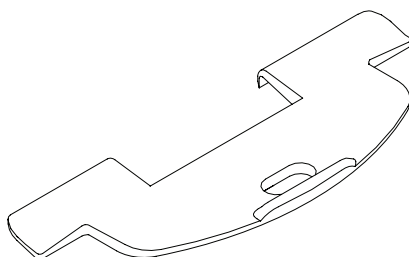

CONTENTS

Getting Started:

Product View	1
Tools and Fasteners Needed	2

Installation:

Installation Overview	3
Mounting Types and Window Terminology	3
Mount the Installation Brackets — Reveal Mount	4
Mount the Installation Brackets — Face Mount	5
Mount the Installation Brackets — End Mount	7
Install the Shade	8
Attach Hold-Down Brackets (Optional)	8
Install the LiteRise Handle(s)	9
Level the Bottom Rail (If Necessary)	9

Operation:

Operate the Shade	10
Troubleshooting	11

Care:

Removing the Shade (If Necessary)	12
Cleaning Procedures	12

Product View

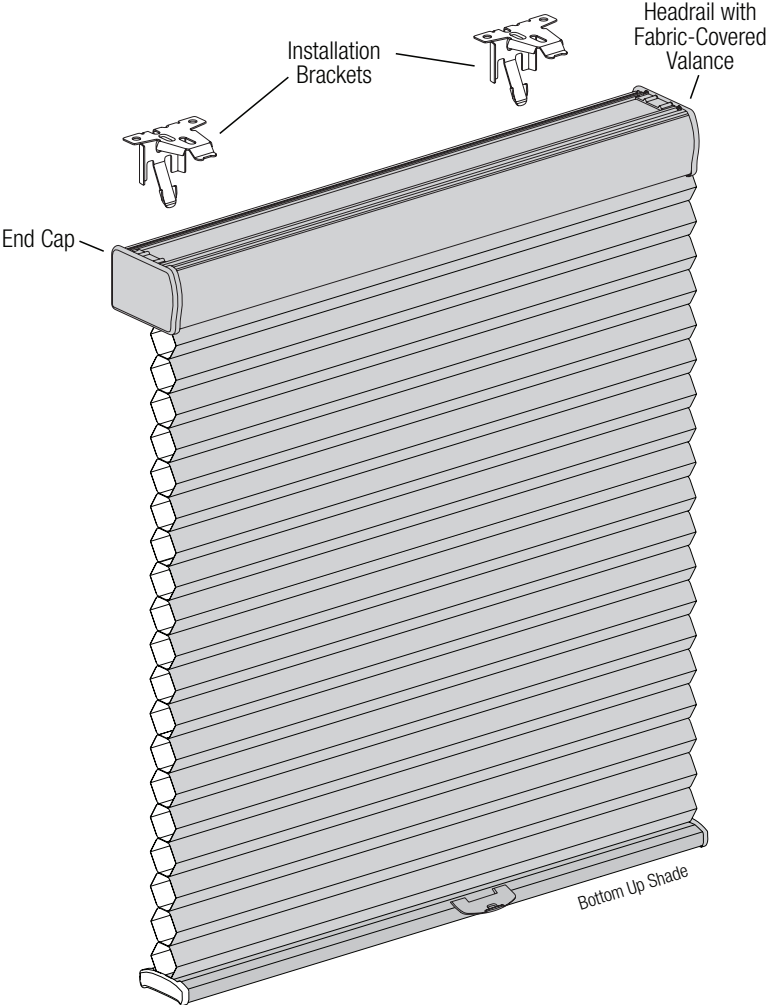

GETTING STARTED

Thank you for purchasing WHISPER® Cellular LiteRise shades. With proper installation, operation, and care, your new shades will provide years of beauty and performance.

Please thoroughly review this instruction booklet and the enclosed packing list before beginning the installation. If your shade has a protective plastic cover on the fabric-covered headrail, keep the plastic in place until the shade is installed.

Tools and Fasteners Needed

- Flat blade and Phillips screwdriver
- Measuring tape and pencil
- Level (laser level is recommended)
- Power drill, 3mm drill bit, and a 6mm hex driver

In addition, you will need fasteners designed to work with your specific mounting surface(s).

- **#6 Hex Head Screws (Provided).** Two 38mm screws are provided per installation bracket.
- **Longer #6 Hex Head Screws (Not Provided).** If using spacer blocks, use #6 screws long enough for a secure attachment.
- **#6 Flat Head Screws (Provided).** If end mounting the shade, use two 38mm screws per installation bracket.
- **Speed Nuts and Screws (Provided).** Extension brackets come with speed nuts and screws.
- **Drywall Anchor (Not Provided).** Use drywall anchors when mounting into drywall.



#6 x 38mm
Hex Head Screw
(Provided)



Longer #6 Hex Head Screw
for Use with Spacer Blocks
(Not Provided)



#6 Flat Head Screw
for Use with Common
Headrail End Mounts
(Provided)



Speed Nut
and Screw
(Provided with Ea
Extension Bracke

Installation Overview

- Your order will include the correct number of installation brackets for your shade width, as shown in the table.

10mm and 20mm
Installation
Bracket



Shade Width (mm)	Brackets Required
310 – 915	2
916 – 1830	3
1831 – 2745	4
2746 – 3040	5

Mounting Types and Window Terminology

If the installation brackets are mounted correctly, the rest of the installation process follows very easily. To prepare for this important first step, review the mounting types and basic window terminology illustrated below.

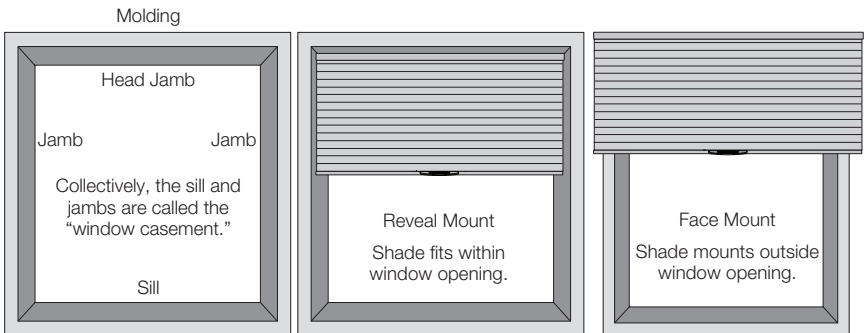

- Refer to the appropriate page below based on your order:

- **Reveal Mount, see page 4.**
- **Face Mount, see page 5.**
- **End Mount, see page 7.**

INSTALLATION

Mount the Installation Brackets — Reveal Mount

- Measure 50mm from each jamb for bracket location.
 - If more than two installation brackets came with your order, space additional bracket(s) evenly between the two end brackets and mark their location. Mount into wood whenever possible.

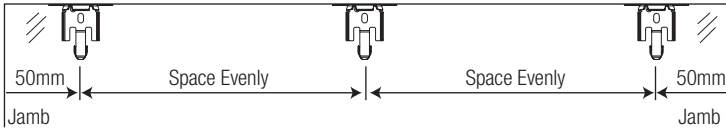

- Center the brackets on your marks, then mark the screw holes.
 - The minimum casement depth for mounting the installation brackets is 10mm. Mark both of the winged screw holes with the shallow mounting depths.
 - The minimum casement depth for a fully recessed mount is 60mm for 20mm and 10mm cell size. Mark the center screw hole when depth permits.

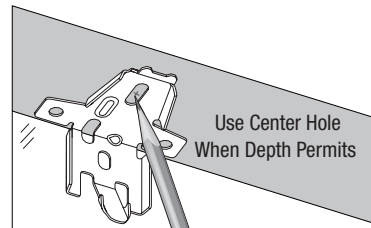
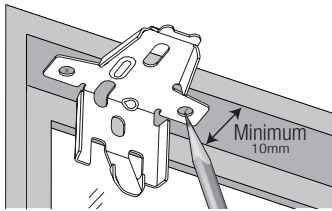

IMPORTANT: The front edges of the brackets must be level and aligned to each other.

- Drill the screw holes using a 3mm drill bit.
 - CAUTION:** Use drywall anchors when mounting into drywall.
- Use a level to check that the mounting surface is level. Shim the brackets if necessary.
- Attach the installation brackets using the screws provided.

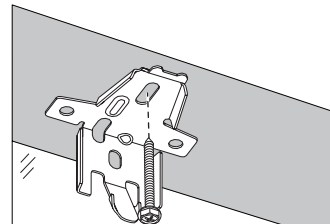
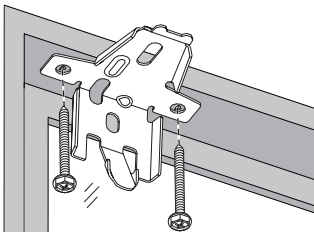

Proceed to "Install the Shade" on page 8.

Mount the Installation Brackets — Face Mount

- Center the shade over the window opening at the desired height. Use a pencil to lightly mark each end of the headrail on the mounting surface.
 - Alternatively, measure the width of the headrail and use that width to mark the headrail end points over the window opening.
- Mark 50mm from each end of the headrail.
 - If more than two installation brackets came with your order, space additional bracket(s) evenly between the two end brackets and mark their location.

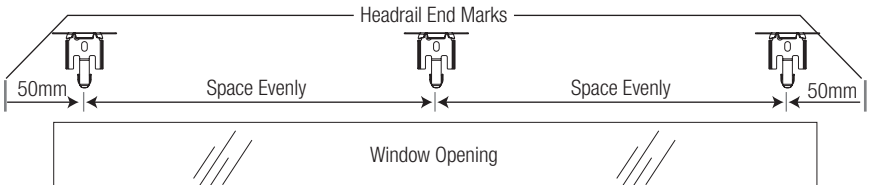

- Center the installation brackets on your marks and mark where to drill the screw holes.
 - A minimum flat vertical surface of 30mm for installation brackets or extension brackets is required.
 - The top of the installation brackets or extension brackets should be at the desired height. The brackets should be level and aligned.
 - When using extension brackets, mark two screw holes per bracket.

CAUTION: The rear of the brackets must be flush against a flat mounting surface. *Do not mount brackets on curved molding.*

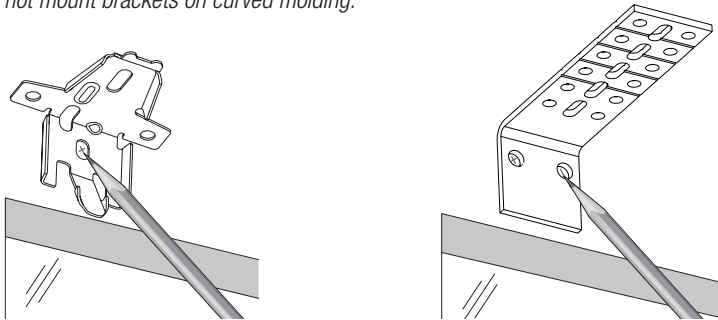

- Drill the screw holes using a 3mm drill bit.

CAUTION: Use drywall anchors when mounting into drywall.

INSTALLATION

- Attach the installation or extension brackets using the screws provided.

IMPORTANT: The front edges of the installation brackets must be level and aligned to each other.

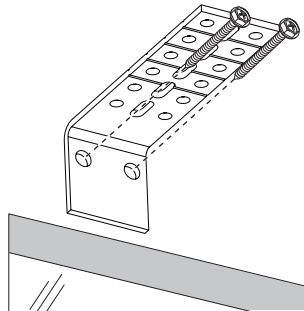
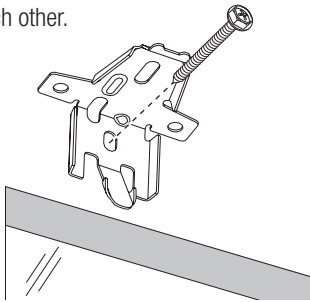

- If using spacer blocks, first attach the installation bracket to the 13mm spacer block before stacking additional spacer blocks together.

- Insert the legs of the installation bracket into the tabs on the spacer block.
- Then rotate the installation bracket back.

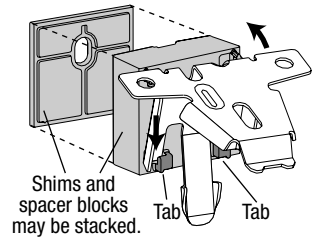

- Attach the spacer block/installation bracket to a flat vertical mounting surface with a #6 mounting screw long enough for a secure installation.

- A maximum of 40mm of spacer blocks per installation bracket is recommended.
- The top of the spacer blocks should be at the desired shade height.

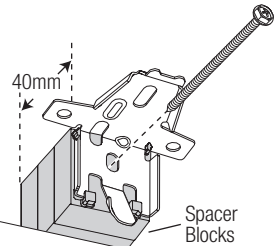

IMPORTANT: For 38mm pleat size a 6mm rear clearance and a minimum of 3mm spacer block is recommended.

IMPORTANT: The front edges of the installation brackets must be level and aligned to each other.

IMPORTANT: Use drywall anchors when mounting into drywall.

- If using extension brackets, attach an installation bracket to the underside of each extension bracket using the provided screws and speed nuts.

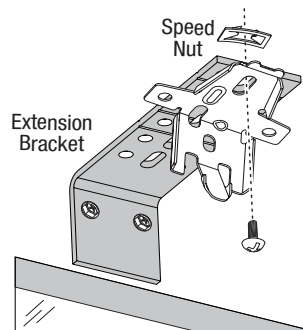
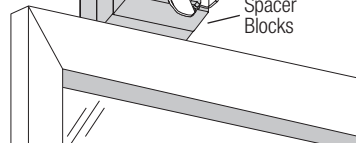

Proceed to "Install the Shade" on page 8.

Mount the Installation Brackets — End Mount

End mount the headrail when conventional mounting techniques will not work — for example, in an arched window opening.

- Position the end mount brackets so that the top of the attached installation brackets equal the ordered height of the shade.

CAUTION: Both brackets *must* be installed at the same depth and height.

- Mark both screw holes.
 - The mounting surface must be vertical and flat, not part of an arched curve.
 - Minimum mounting depth is 30mm for 10mm and 20mm cell sizes . Minimum mounting depth for a fully recessed end mount is 60mm for 10mm and 20mm cell sizes.
- Drill the holes using a 3mm drill bit.
- Attach the end mount installation brackets using the flat head screws provided.

CAUTION: Drywall mounting is not recommended.

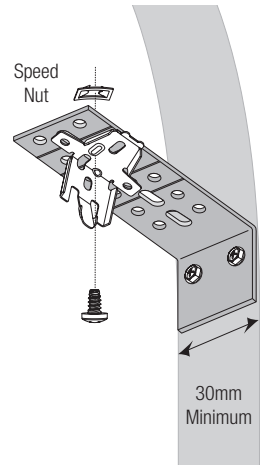

Proceed to “Install the Shade” on page 8.

INSTALLATION

Install the Shade

- Fit the front channel on top of the headrail onto the front lip of the installation brackets.
- Push the headrail up and back until it snaps into place.
- Check to ensure the headrail is securely in the brackets.
 - Check that the bottom of the headrail is snapped into the base of each bracket.
 - Check that the front lip of each bracket is in the front channel of the headrail.
 - If any brackets are not installed correctly, release the shade and reinstall. See “Removing the Shade (If Necessary)” on page 12.

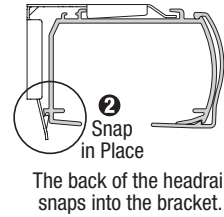
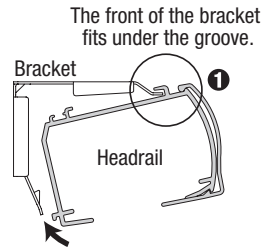

Good

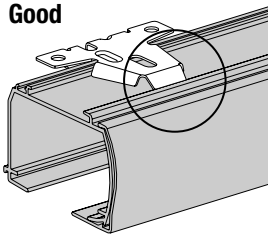

Bad

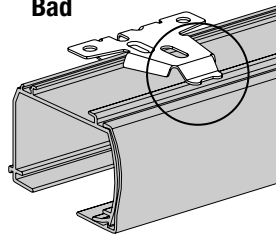

Attach Hold-Down Brackets (Optional)

Hold-down brackets provide stability and prevent swaying by securing the bottom rail (i.e. often used in French door applications). Hold-down brackets can only be used on outside mount shades.

- Lower the shade and place the pins from the hold-down brackets into the bottom rail end caps.
- On the mounting surface, mark the screw holes.
- Drill the screw holes using a 3mm drill bit.
 - Check that the brackets are level and aligned.
- Attach the hold-down brackets using the screws provided.

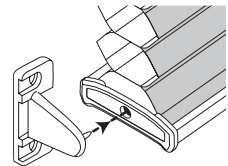

Install the LiteRise Handle(s)

Using the LiteRise handle provides touch of finger ease and convenient shade operation.

IMPORTANT: For shades over 1520mm wide, two handles will be provided. Space these handles evenly across the rail.

- Attach the handle at the center of the bottom rail.
 - Hook the prongs of the handle onto the lip of the bottom rail.
 - Rotate the handle **down** until it snaps onto the bottom rail.
- If your shade has a middle rail, attach the other handle at the center of the middle rail. To identify the middle rail, see “Product View” on page 1.

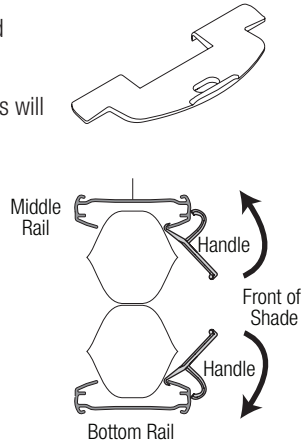

IMPORTANT: With Top Down/Bottom Up and DuoLite shades, attach the middle rail handle upside-down.

Shade Height Adjustment

Shade height and adjustments to level the bottom rail can be made by adjusting the cord on the underside of the bottom rail. Locate the ferrule, seated in a pocket in the bottom rail. Remove the ferrule by pulling on the excess cord. If the cord has been trimmed, you will need to use needlenose pliers to access it.

- To shorten the cord, hold the cord tight under the ferrule. Then slide the ferrule up toward the pocket. Image
- To lengthen the cord, hold the cord tight between the pocket and the ferrule. Then slide the ferrule down.
- After adjusting, place the ferrule fully back into the pocket. Once you are certain of the final adjustments, tape the extra cord length to the bottom rail, or into the groove on the bottom rail (for future adjustments).
- If the ferrule has come off the cord, thread the end of the cord into the tapered end of the ferrule. Loop the end around the ferrule and back through the tapered end. Make sure the loop fits into the groove on the side of the ferrule.

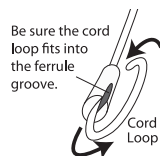
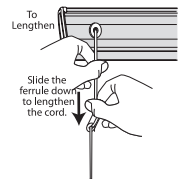
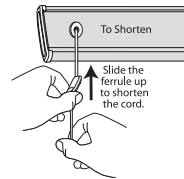
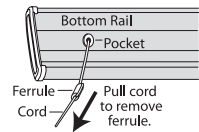

OPERATION

Operate the Shade

For better support and smoother operation, use the handle when raising and lowering the shade.

To Raise the Shade

- Slowly and steadily push up on the bottom rail handle. Allow the shade to stack evenly.

To Lower the Shade

- Slowly and steadily pull down on the bottom rail handle.

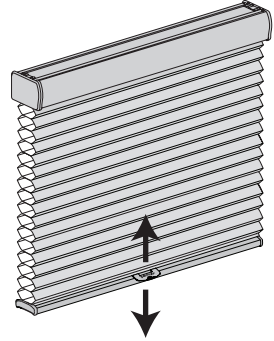

To Raise or Lower the Middle Rail or Bottom Rail (for Top Down/Bottom Up and DuoLite Shades).

Shades with the Top Down/Bottom Up and DuoLite design options have two moving rails. You can operate these shades as described in this section.

- With the bottom rail fully lowered, slowly and steadily push up or pull down on the middle rail handle.

NOTE: The bottom rail must be in the fully lowered position to operate the middle rail.

- With the middle rail fully raised, slowly and steadily push up or pull down on the bottom rail handle.

NOTE: The middle rail must be in the fully raised position to operate the bottom rail.

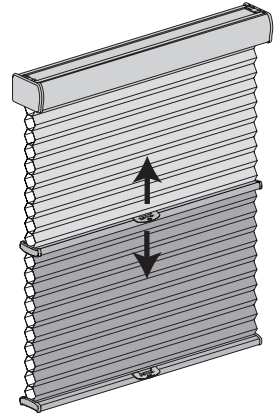

Troubleshooting

Problem	The shade is hard to raise or lower, or will not raise or lower.
Solution	<p>Make sure that the shade fabric is not caught between the installation bracket and the headrail.</p> <p>Check that the headrail and installation brackets are level and aligned. Shim the installation brackets to level the headrail, if necessary.</p> <p>If hold-down brackets are used, make sure they have been released before operating the shade.</p>
Problem	The shade raises or lowers unevenly or the bottom rail is uneven when fully raised.
Solution	<p>Check that the headrail and installation brackets are level and aligned. Shim the installation brackets to level the headrail, if necessary.</p> <p>Check to see if there is an obstruction in the shade's path. If a shade hits an obstruction as it is lowered it may become misaligned. This may cause the shade to be angled or tilted when fully raised. Try lowering the shade completely, then raising it to allow it to self-correct.</p> <p>Adjust the shade. See "Level the Bottom Rail (If Necessary)" on page 9.</p>
Problem	The shade will not fit into the installation brackets.
Solution	<p>Check that the installation brackets are level and aligned. Shim the installation brackets to level the headrail, if necessary.</p> <p>Be sure the heads of the screws are flush against the installation bracket.</p> <p>Check that the headrail is completely inserted into the installation brackets. See "Install the Shade" on page 8.</p>

Removing the Shade (If Necessary)

- Lower the shade approximately 100mm.
- While holding the headrail, push back on the bottom tab of the installation bracket to release the bottom edge of the headrail.
- After releasing the bottom edge, roll the back of the headrail down and out from the bracket.

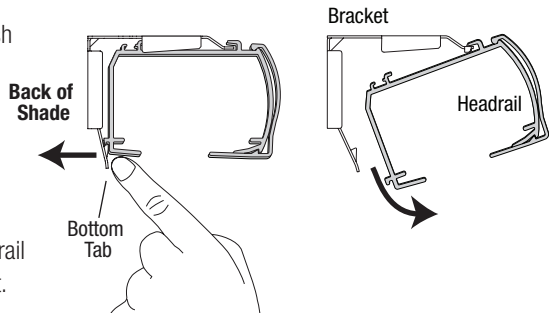

Cleaning Procedures

WHISPER® Cellular shades are made of anti-static, dust-resistant fabric which repels dirt and dust. For most honeycomb fabrics, the following cleaning options are available.

Dusting

- Regular light dusting with a feather duster is all the cleaning that is needed in most circumstances.

Vacuuming

- For deeper cleaning, vacuum gently with a brush attachment.

Compressed Air/Hair Dryer (Cool Setting)

- Use compressed air or a hair-dryer on a cool setting to blow dust and dirt off shades.

Spot-Cleaning

CAUTION: Do not spot-clean blackout fabrics or the fabric-covered valance.

- Prepare a solution of warm water and a mild detergent.
- Dampen a clean cloth in the solution and wring it out.
- Dab the spot with the dampened cloth until it is gone. Do not rub the fabric.
- Allow the shade to dry in the completely lowered position.

Bathtub Cleaning/Water Immersion

CAUTION: Do not immerse all blackout fabrics, Daybreak, Dusk, Sunterra. Do not immerse the fabric covered headrail.

- Immerse the shade in a basin or bathtub filled with warm water and a mild detergent. Never immerse the headrail into the solution.
- Rinse with clean water.
- Before removing from the rinse water, fully raise the shade and tilt it to allow excess water to drain off.
- Dry the shade completely in the lowered position.

Ultrasonic Cleaning

CAUTION: Do not ultrasonically clean fabric-covered valances. Do not ultrasonically clean blackout fabrics.

- Some honeycomb fabrics can be ultrasonically cleaned by a professional.
- Specify that a mild detergent solution be used.
- Never immerse the headrail into the solution.
- Dry the shade completely in the lowered position.

